

Industry Size

9.18 Billion

by 2023

7.37%

CAGR growth between 2017 and 2023

Source: MarketsandMarkets

Types of ASRS



Unit Load

Machines that store large loads (usually 1,000+ pounds), typically on pallets with storage rack structure, reaching 100 feet or more tall.

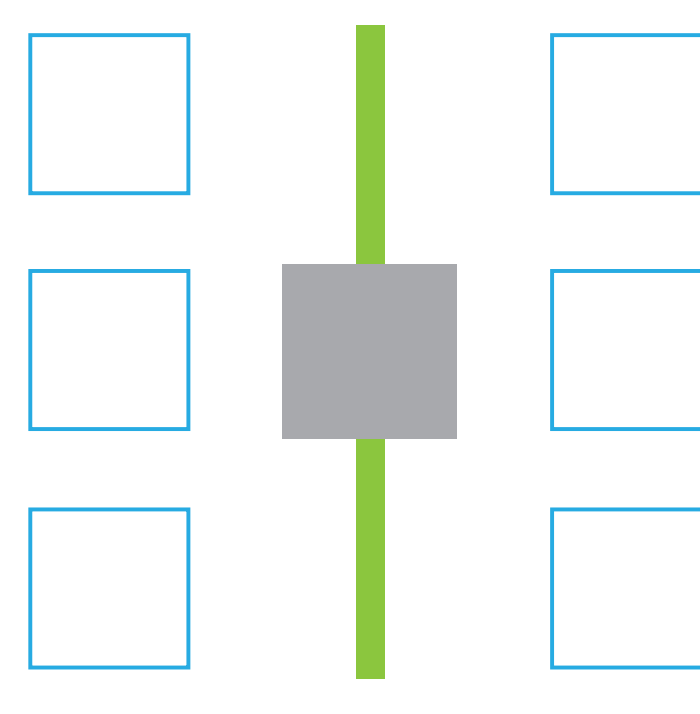

Mini Load

Operating the same way as a unit-load AS/RS, a mini-load AS/RS handle lighter loads, usually weighing less than 1,000 pounds.

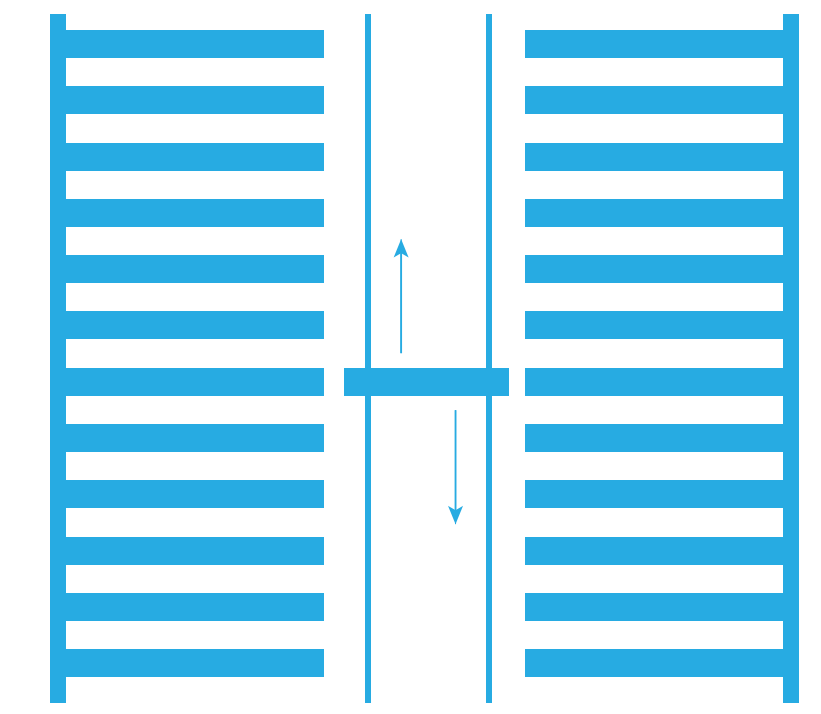

Vertical Lift Modules

VLMs consist of a column of trays in the front and back of the module with an automatic inserter/extractor in the center that stores and retrieves the required trays.

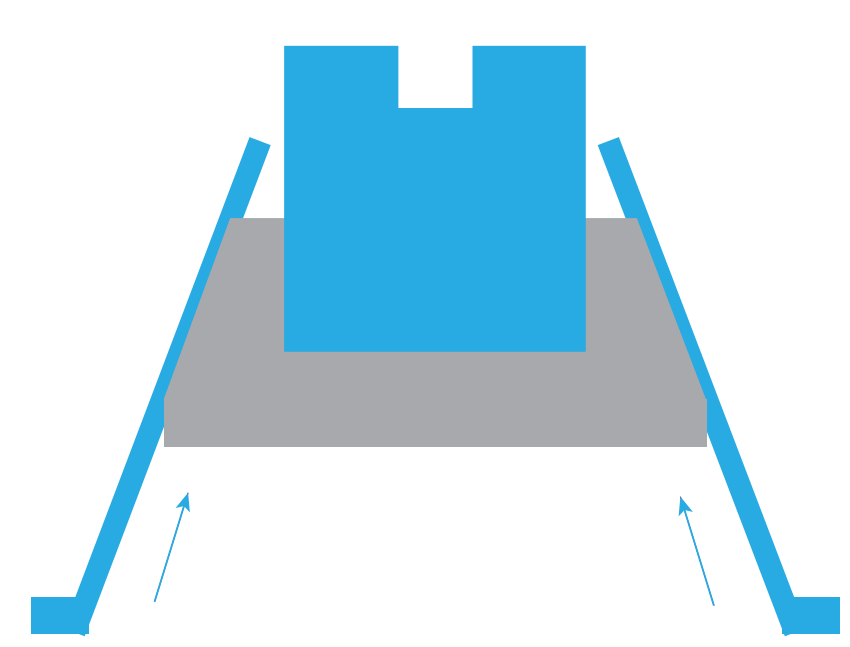

Shuttles

Shuttles are used for the automated handling of totes, trays, cartons or all three in the same system – for either warehousing or manufacturing.

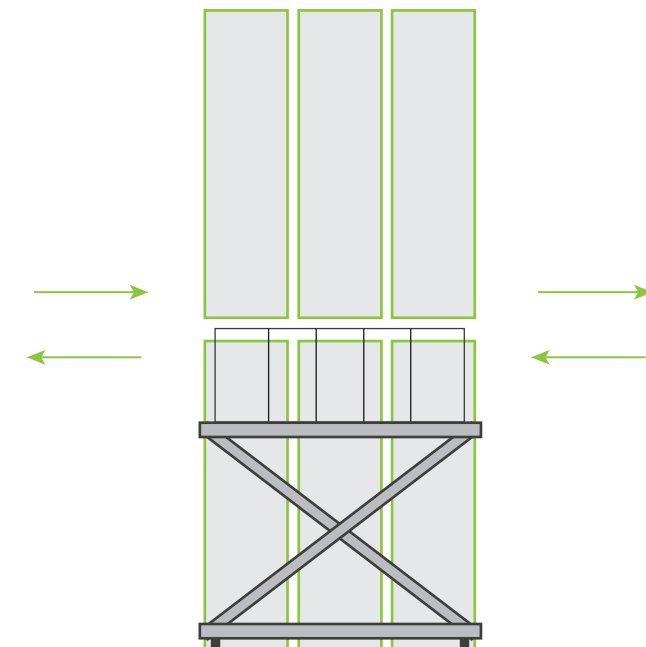

Horizontal Carousels

Ideal for storing small parts and pieces, horizontal carousels are comprised of a series of bins that rotate horizontally around a track.

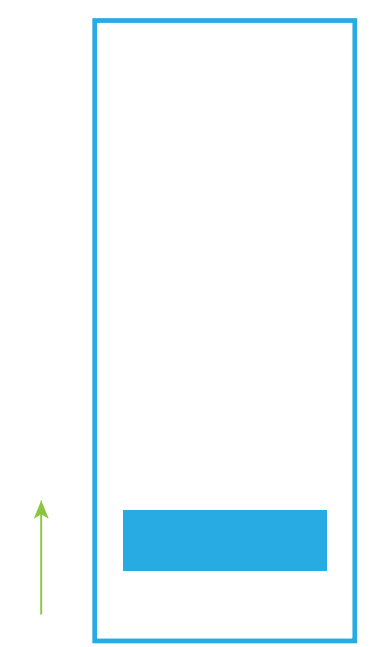

Vertical Carousels

Rotating vertically, like a Ferris wheel, vertical carousels house a series of shelves or carriers to provide high-density storage.

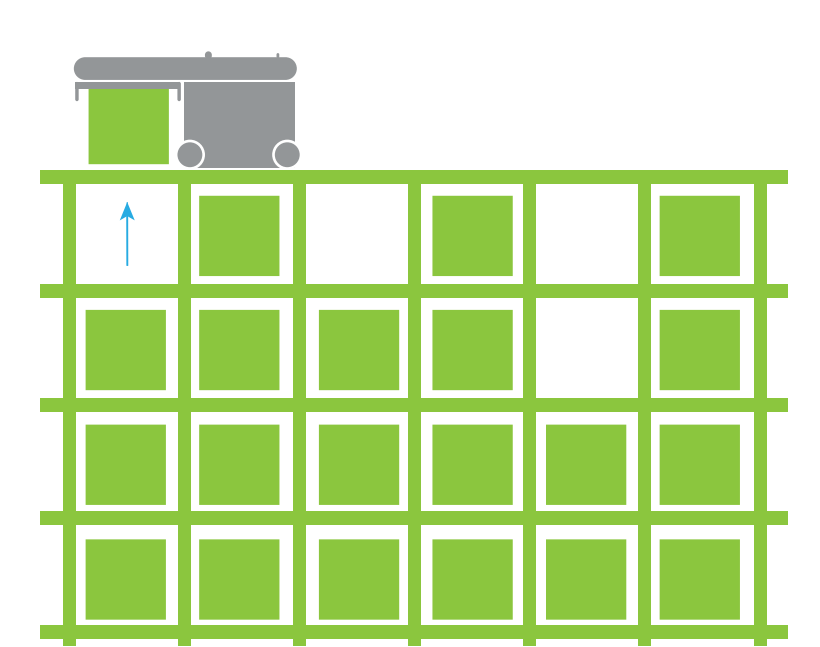

Cube Based Storage

Ultra-high density goods-to-person piece picking system which utilizes robots to store and retrieve inventory bins from a cubical storage grid.

Benefits



Improves throughput

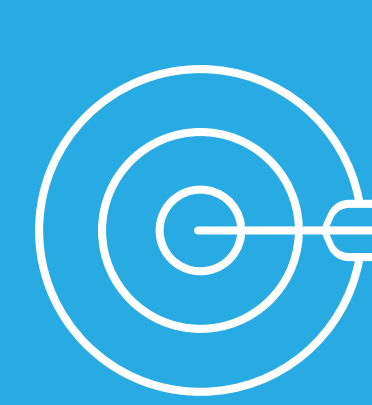

Increases accuracy levels to 99.99%+

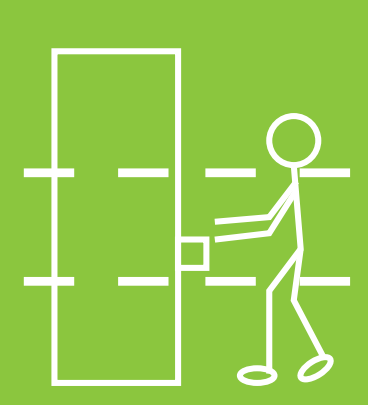

Increases ergonomics and worker safety

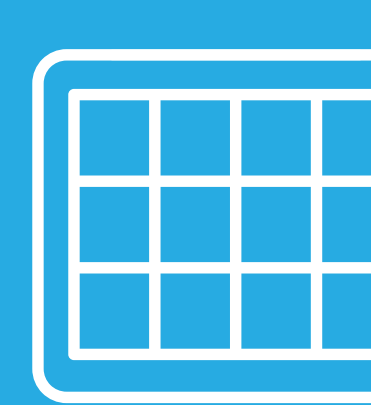

Provides highest possible storage density



Saves up to 85%+ of otherwise wasted floor space



Increases labor productivity up to 85%



Enhances product security



Provides real-time inventory control

Interesting Fact

Every U.S. patent ever issued is stored in vertical carousels at the Patent and Trademark Office.



Automated Storage/Retrieval Systems (ASRS) members are the industry's leading suppliers of automated storage/retrieval systems. They supply systems worldwide in virtually every major manufacturing and distribution sector.

AS/RS MEMBERS...

Are committed to safety, innovation and providing the right solution to ensure peak performance.

Learn about our 18 member companies, www.mhi.org/asrs.

Join AS/RS, www.mhi.org/asrs.



COMBINED EXPERIENCE

1,000s

Access to the combined knowledge / experience from thousands of installed systems.

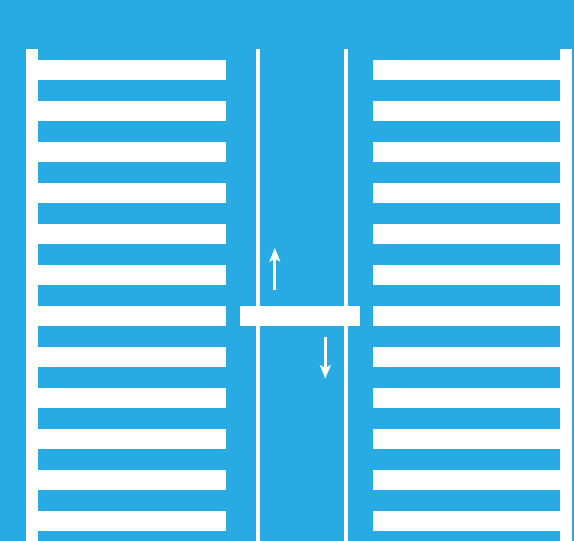

DIVERSITY & INNOVATION

18

Learn from 18 of the world's leading AS/RS companies.

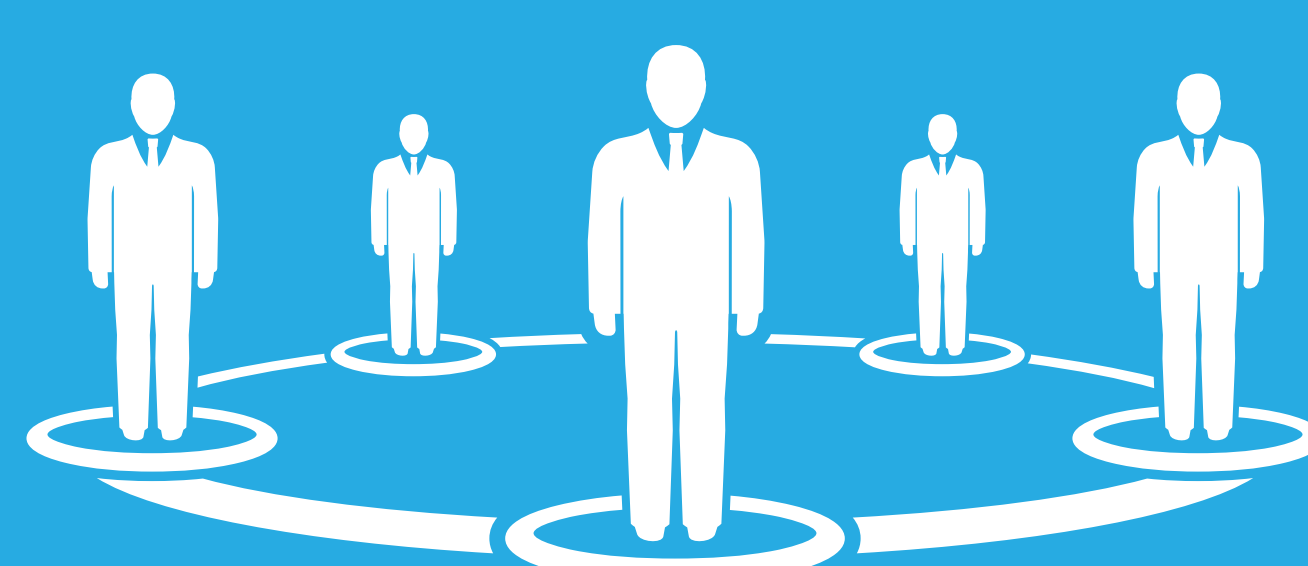

RESOURCES

100s

Hundreds of resources for education and help. Access online website, www.MHI.org, have direct contact* with other members and network at MHI events**.

* Meetings are conducted in a safe harbor environment.

**MHI events include MODEX, ProMat and Spring/Annual meetings and conferences.