

Products  
4225 US



# Live Roller Conveyor Belts

Habasit-Solutions in motion



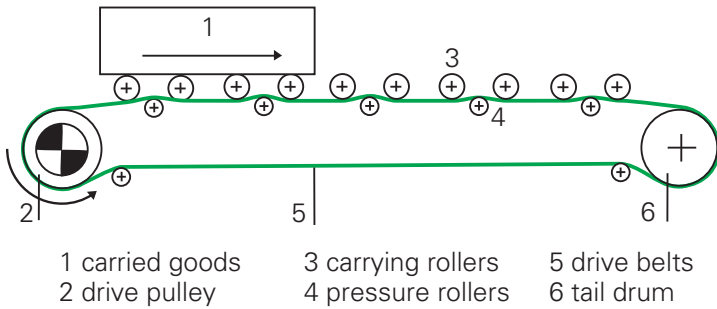

Live roller conveyors are used throughout distribution centers, warehouses, and packaging/shipping departments for efficient transport of packages and goods. The belt is a critical component of the conveyor but may not even be seen. As shown in the diagram to the left, the belt is supported by pressure rollers, which force it up against the carrying rollers, causing them to rotate and move products along the conveyor.

Live roller conveyor systems can be segregated into three types of systems:

- 1) Continuous running (CR)
- 2) Low pressure accumulation (LP)
- 3) Zero pressure accumulation (ZP)

Zero pressure systems can handle the widest range of products. They are very gentle on products being transported because the belt is removed from the carrying rollers after products accumulate to fill up the designated zone.

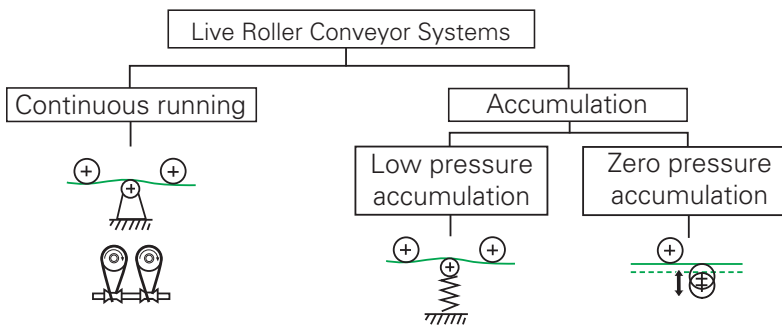

Habasit manufactures a wide range of products for all live roller applications, from our narrow, high efficiency power transmission belts, to low noise nonwoven belts, to traditional wide belts. We also specialize in providing high quality round belts or "O-Rings" for line shaft live roller conveyors. No matter which system(s) you depend on in your facility, our live roller specialists can provide a solution to: reduce noise, increase throughput, reduce downtime, or reduce marking of packages.

## Zero Pressure Accumulation

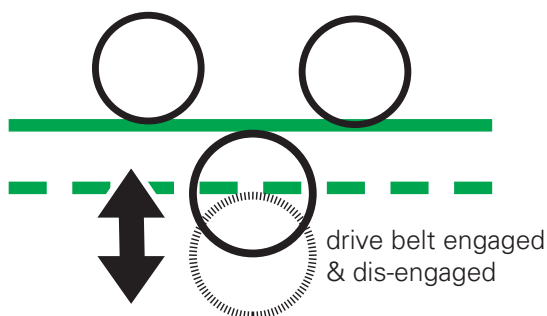

## Zero Pressure Accumulation System

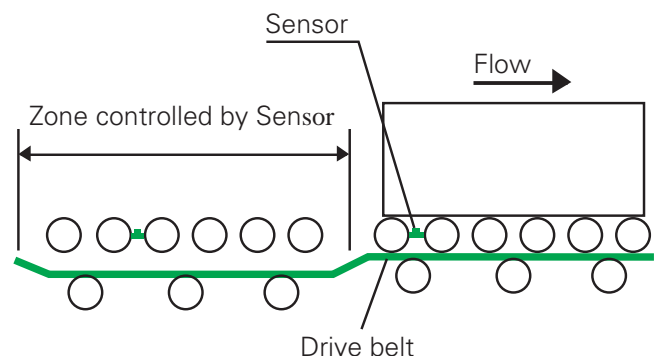

Habasit's premium wide live roller belts (typically greater than 2 inches wide) are found in the Ulti-Mate® range. The Ulti-Mate® products are engineered with a nonwoven belt construction which provides many advantages over standard domestic PVC belts.

### Features and Benefits

- Improved lace holding capability : *reduced maintenance time due to lacing repair or replacement, meaning less downtime*
- Low noise generation : *improved working conditions, worker safety*
- Low belt stretch : *reduced maintenance time due to re-tensioning and less downtime*
- Tear resistance : *extended belt life and less downtime*
- Excellent flexibility : *reduced energy consumption*

The Ulti-Mate® belts, without PVC covers, have additional advantages over other nonwoven belts in that they are saturated with rubber materials instead of PVC. This eliminates “pick-off” or marking of rollers which can leave black marks on packages.

The Ulti-Mate® series belts (UM, UMS) are also anti-static so will “bleed off” static charges which may build up and ruin sensitive electronic readers or sensors or shock line workers.

The TrackMate® series of live roller belts are a more economical option for a nonwoven belt. They too offer low noise running and unparalleled lace holding.

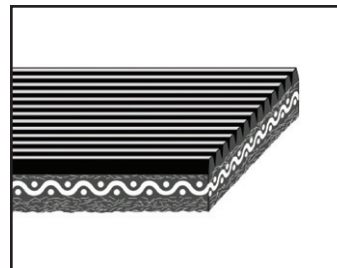
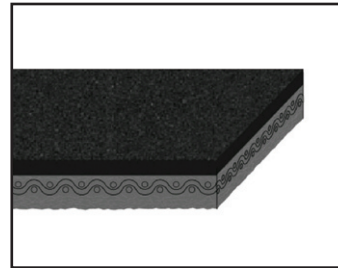

Systems utilizing wider conveyor belt (>2 inch) which is usually laced

Type	Notes	Cover material	ZP	LP	CR	Belt thickness (in.)	Min. pulley diameter (in.)	Low noise
UM140HMBBS-B	elimination of “pick-off” or marking of rollers	Latex	X	X		0.14	2.0	Y
UM140HMSD-B			X	X		0.15	2.0	Y
UMS130FBS-B			X			0.13	2.0	Y
UMS130LR-B	positive drive surface, improved lace holding	PVC	X		X	0.17	2.0	Y
UMS130EMB-B			X		X	0.16	2.0	Y
TMIPH533EMB	high strength, rigidity, lace holding, positive drive surface, low noise pulley side	PVC	X		X	0.15	3.1	Y
TMIPH135LR			X		X	0.17	3.0	Y
APH120COS	high transverse rigidity & strength, positive drive surface, improved lace holding	PVC	X		X	0.15	3.0	N
APH150LR			X		X	0.17	3.5	N
Allveyor® COS	economical, positive drive surface	PVC	X		X	several		N
Allveyor® CBS			X		X	several		N

Habasit's high efficiency, flat power transmission belts are commonly used by manufacturers of live roller conveyors at narrow widths, even on long conveyors, because of their outstanding characteristics.

The TC, TCF and TF series flat power transmission belts offer:

- Excellent dimensional stability in changing environmental conditions (humidity, temperature) which means no re-tensioning
- Very high strength, yet very flexible, highly engineered design which reduces energy consumption, component sizes, and extends belt life
- Easy and quick joining on the conveyor with Habasit tools that do not require adhesives for bonding

Habasit also offers several high strength HabaFLOW® conveyor belts that can be utilized in low pressure accumulation applications, or that can be used with a v-guide installed to support tracking.

Habasit now offers an economical alternative to our traditional narrow live roller belts that utilize woven fabrics as strength members. The construction of this new offering makes use of flexible, high strength, Aramid cords which are protected by thermoplastic layers to produce a belt which can be spliced on your conveyor quickly and easily, without the use of adhesives. This new belt is manufactured on our timing belt line, so that Aramid cords have precise positioning to provide optimal tracking and flexibility properties. The backside fabric is engineered to reduce drag, which increases load carrying capacity.

Systems utilizing more narrow (<2 inch), high efficiency belts usually spliced on system or made endless

Type	APPLICATION						Belt thickness (in.)	pulley diameter (in.)	Joint type
	common width	pressure rollers	pressure pads	ZP	LP	CR			
APH-150HTS		x		x	x	x	0.20	4	#3HT
CM-18/30F		x		x		x	0.13	2.4	FP
EMB-27EHBT*	3 in.	x		x	x	x	0.11	3.1	FP, #1HT
ENU-50AXB*		x		x	x	x	0.10	3.1	FP
NNT-20ECDV*		x		x	x	x	0.14	5.0	FP, #1HT
TCF-50H	60mm	x		x		x	0.08	2.4	FP
TC-55ER		x		x		x	0.12	2.8	FP
TCF-55EL		x		x		x	0.14	4.0	FP
TF-22		x		x		x	0.09	2.4	FP
TF-33	6 in.	x		x		x	0.12	4.0	FP
TF-75T	42 & 46mm	x	x	x		x	0.17	5.5	FP
UM140HMSD-B		x		x	x	x	0.15	2.5	#1HT

\* V-guide tracking option available

**Power transmission belts / live roller drive belts  
(Polyester and Aramid® reinforced)**

Habasit power transmission belts are especially suitable for live roller conveyor applications (continuous / zero pressure systems). A wide range of power transmission capability and belt strengths are available. All belts can be joined with an easy to use, reliable joining system.

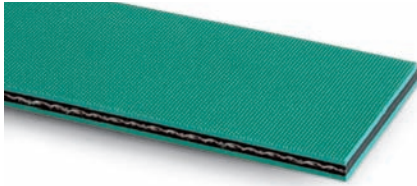

**Features:**

- High admissible work load
- High longitudinal flexibility
- High Friction NBR rubber surface
- Stable modulus of elasticity
- Low sensitivity to humidity
- Low energy consumption
- Permanently anti-static
- Simple and quick joining system (Flexproof)

**Benefits:**

- Small pulley diameters suitable, compact design
- Low energy consumption
- Forgiving in case of shock loads (stop and go operation)
- Reduced maintenance
- Long service life
- Constant power input over entire belt life
- Reduced belt wear
- Positive flow response
- High output / throughput
- Long service life
- High dimensional stability
- No re-tensioning
- No downtimes
- High dimensional stability
- No re-tensioning
- No downtimes
- Lower energy costs
- Less dust and dirt stability
- Process reliability
- Low maintenance cost
- Easy handling
- Adhesive-free joint
- Minimum equipment needed
- Short machine downtimes

Habasit's round belts or "O-rings" for line shaft, live roller conveyors are the toughest in the industry. Both Habicord® and Polycord® belts are made with high strength, high quality TPU material without the fillers that some other companies use. The result is a product that will not stretch out and that resists abrasion, which reduces belt diameter until the belt can no longer drive the roller.

Our endless round belts are made on sophisticated automated joining equipment which insures:

- Reliable joint quality so belts will not fail at the splice
- Consistent dimensional accuracy so you get the full power transmission required
- Consistent alignment of the ends during joining to prevent belt from "twisting" during operation, which accelerates abrasion

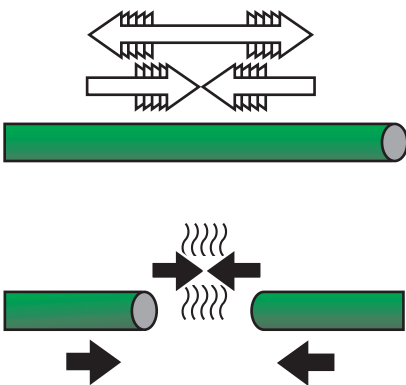

### Features

- Elastic material (Polyurethane)
- Simple and quick joining (Quickmelt - butt joint)

### Benefits

- Forgiving / reducing shocks and able to cope with intermittent overload
- No tensioning device needed
- No re-tensioning required
- Simple and cost-effective machine design
- Easy to handle welding method
- High strength over joining area
- Fast belt exchange possible
- Maintenance-friendly product
- Long belt life

## Tools

Habasit offers a wide range of easy to use and reliable preparing and splicing tools for use in the field so that you can keep the conveyors running by installing belts yourself. Many of our narrow live roller belts can be easily joined without the use of adhesives. The AF-100/US is a portable device used to cut "fingers" in the belt before splicing. The PF-61 and PF-101 are presses used for joining the ends of the belt together and require minimal cook times. The PF-101 is air cooled to reduce downtime.

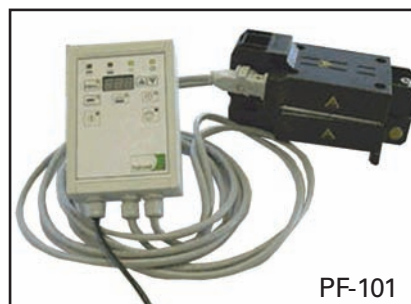
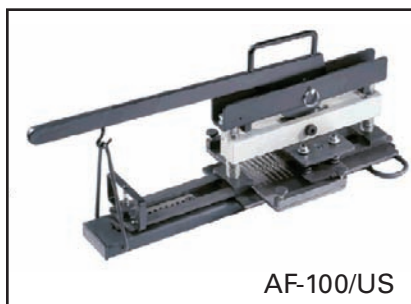

### Systems utilizing round belts driven by a line shaft "o-rings"

	color	diameters (mm)	length
Habicord®	translucent	3,4,5	any size
Polycord®	green	3,4,5	any size

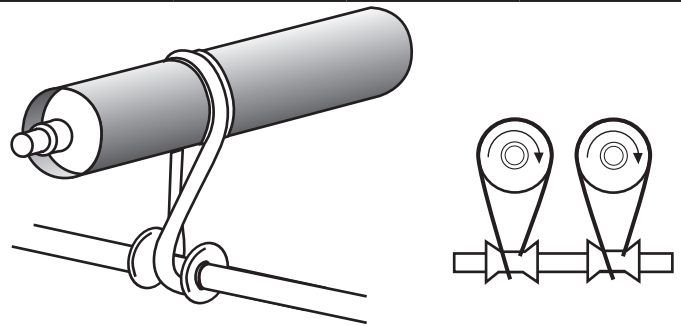

## Worldwide leading product range

Habasit offers the largest selection of belting and related accessories in the industry. Our response to any request is nothing less than a specific, tailor-made solution.

A selection of our product ranges:



**HabaFLOW®**  
Fabric based conveyor and processing belts

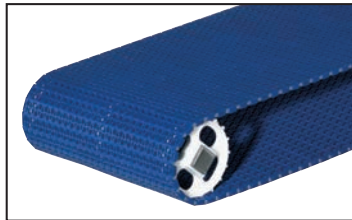

**HabasitLINK® / KVP®**  
Plastic modular belts



**HabaDRIVE®**  
Power transmission belts

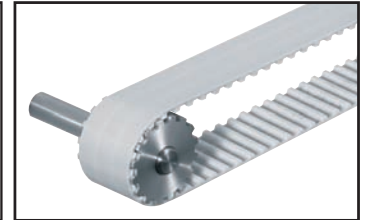

**HabaSYNC®**  
Timing belts

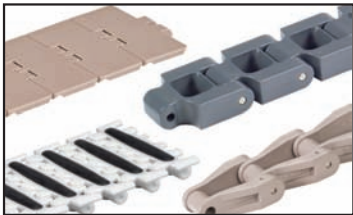

**HabaCHAIN®**  
Chains (slat and conveyor chains)



**HabiPLAST®**  
Profiles, Guides, Wear strips

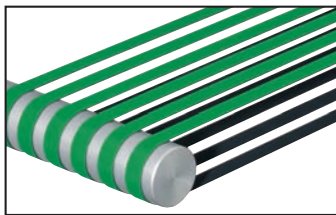

**Hamid® and Traditional**  
Machine tapes



Seamless belts

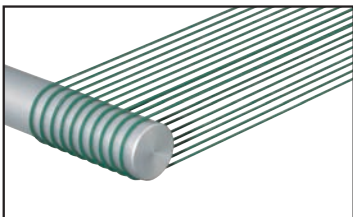

**Polycord®**  
Round belts

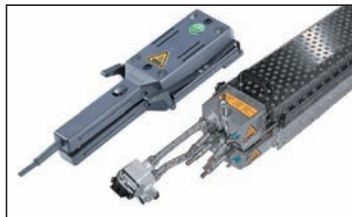

Fabrication tools

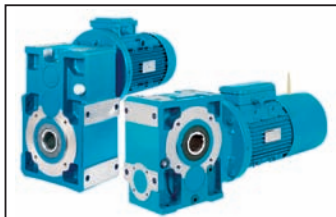

**Rossi**  
Gear Reducers & Gearmotors

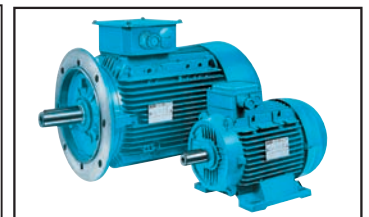

Electric motors

**At Habasit, we listen to our customers, innovate continuously and deliver reliable solutions to meet your every need.**

## Customers come first

At Habasit we understand that our success depends on your success. We offer solutions, not just products; partnership, not just sales. Since our foundation in 1946, Habasit has brought this understanding of customer needs to life every day and for every application. That's why we're recognized as the market leader in light weight belting.

## Committed to innovation

Habasit is strongly committed to the continuous development of innovative, value-added solutions. Over 3% of our staff are dedicated exclusively to R&D, and our annual investment in this area exceeds 5% of sales.

## Certified for quality

We deliver the highest quality not only in our products and solutions, but also in our employees' daily work processes. Habasit is certified according to ISO 9001:2000.

## Habasit America

305 Satellite Boulevard  
Suwanee, GA 30024  
[www.habasitamerica.com](http://www.habasitamerica.com)

ph: (800) 458-6431  
fax: (800) 422-2748  
email: [distributioncenterbelts@us.habasit.com](mailto:distributioncenterbelts@us.habasit.com)