

EZ-LIGHT® TL50 Beacon Tower Light

Multi-Color General-Purpose or Audible Indicators



For the latest technical information about this product, including specifications, dimensions, and wiring, see www.BannerEngineering.com.

The EZ-LIGHT® TL50 Beacon Tower Light is a cross between the TL50 tower light and the K50 beacon. This compact design is extremely intense and can even be used in outdoor applications.



- Rugged, cost-effective, and easy-to-install multi-segment indicators
- Illuminated segments provide easy-to-see operator guidance and indication of equipment status
- Displays up to 5 colors
- Optional audible function with variable intensity
- Available in black or light gray housing
- Audible models available with standard or sealed audible element
- Continuous, pulsed, and staccato tones available
- Immune to ambient light, EMI, and RFI interference
- 12 to 30V dc or 24V ac operation
- No assembly required
- Consult model key about flashing and rotating options (see [TL50BL Tower Lights Model Key](#) on page 2)

Multi-Color General-Purpose Models



NOTE: More models are listed on the next page.

Model*	# of LED Colors	LED Function†	Connection**	Inputs
TL50BLRQ	1	Red	4-pin Euro integral QD connector	Bimodal (NPN or PNP)
TL50BLGRQ	2	Green, Red		
TL50BLGYRQ	3	Green, Yellow, Red		
TL50BLBGYRQ	4	Blue, Green, Yellow, Red	5-pin Euro integral QD connector	
TL50BLWBGYRQ	5	White, Blue, Green, Yellow, Red	8-pin Euro integral QD connector	

† The first color listed is the bottom color, going up in successive order. Contact the factory for other colors and color combinations.

* Models with black housing are listed. For gray housing, add suffix "C" at the end of the model number (cabled models) or before the "Q" (QD models), e.g., **TL50BLGYRC** or **TL50BLGYRCQ**.

** Integral QD models only are listed; mating cordset required (see [Quick-Disconnect \(QD\) Cordsets](#) on page 5):

- For 150 mm (5.9 in) PVC pigtail with QD, replace "Q" with "QP" in the model number (e.g., **TL50BLGYRQP**).
- For 2 m (6.5 ft) cable, omit suffix "Q" from the model number (e.g., **TL50BLGYR**).



WARNING: Not To Be Used for Personnel Protection

Never use this product as a sensing device for personnel protection. Doing so could lead to serious injury or death. This product does NOT include the self-checking redundant circuitry necessary to allow its use in personnel safety applications. A sensor failure or malfunction can cause either an energized or de-energized sensor output condition.

Multi-Color Audible Models

Standard Audible*	# of LED Colors	LED Function†	Connection**	Inputs
TL50BLRAQ	1	Red	4-pin Euro integral QD connector	Bimodal (NPN or PNP)
TL50BLGRAQ	2	Green, Red		
TL50BLGYRAQ	3	Green, Yellow, Red	5-pin Euro integral QD connector	
TL50BLBGYRAQ	4	Blue, Green, Yellow, Red	8-pin Euro integral QD connector	

Sealed Audible*			# of LED Colors	LED Function†	Connection**	Inputs
Continuous	Pulsed at 1.6 Hz	Staccato				
TL50BLRALSQ	TL50BLRALS3Q	TL50BLRALS4Q	1	Red	4-pin Euro integral QD connector	Bimodal (NPN or PNP)
TL50BLGRALSQ	TL50BLGRALS3Q	TL50BLGRALS4Q	2	Green, Red		
TL50BLGYRALSQ	TL50BLGYRALS3Q	TL50BLGYRALS4Q	3	Green, Yellow, Red	5-pin Euro integral QD connector	
TL50BLBGYRALSQ	TL50BLBGYRALS3Q	TL50BLBGYRALS4Q	4	Blue, Green, Yellow, Red	8-pin Euro integral QD connector	

† The first color listed is the bottom color, going up in successive order. Contact the factory for other colors and color combinations.

* Models with black housing are listed. For gray housing, add suffix "C" at the end of the model number (cabled models) or before the "Q" (QD models), e.g., TL50BLGYRC or TL50BLGYRCQ.

** Integral QD models only are listed; mating cordset required (see [Quick-Disconnect \(QD\) Cordsets](#) on page 5):

- For 150 mm (5.9 in) PVC pigtail with QD, replace "Q" with "QP" in the model number (e.g., TL50BLGYRQP).
- For 2 m (6.5 ft) cable, omit suffix "Q" from the model number (e.g., TL50BLGYR).

TL50BL Tower Lights Model Key

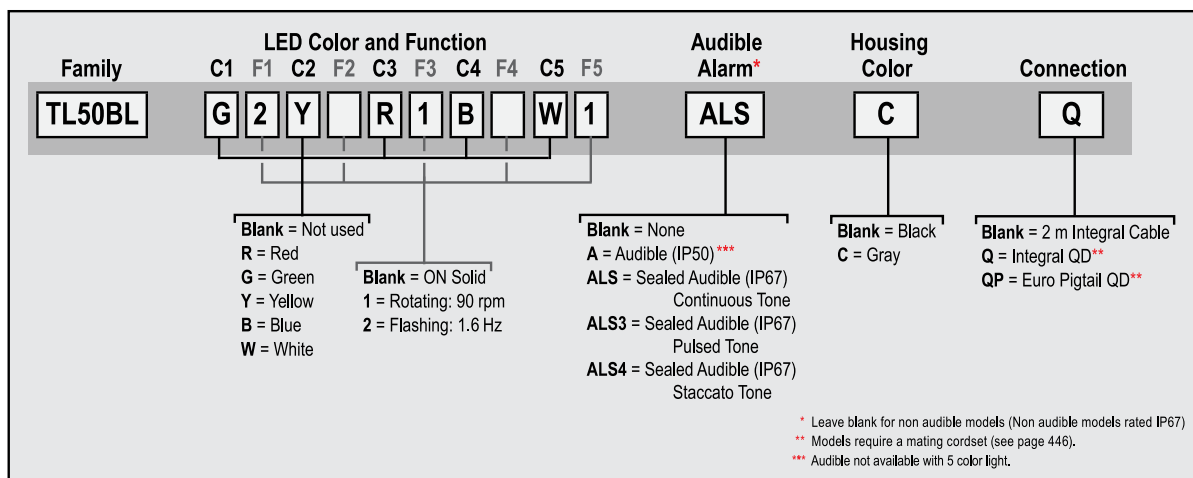

Specifications

Supply Voltage and Current

12 to 30V dc (10% max. ripple); or 21 to 27V ac

Indicators —

Use only with a suitable Class 2 power supply or transformer.

Max. current per LED color:

- at 12V dc: 125 mA
- at 30V dc: 60 mA
- at 21V ac: 80 mA
- at 27V ac: 70 mA

Standard Audible Alarm: 25 mA max. current

Sealed Audible Alarm: 35 mA max. current

Indicators

1 to 5 colors depending on model; Green, Red, Yellow, Blue, and White

LEDs are independently selected

Supply Protection Circuitry:

Protected against reverse polarity and transient voltages

Input Response Time

Indicator ON/OFF: 1 ms (max.)

Connections

Integral 4-pin, 5-pin, or 8-pin M12/Euro-style QD, 150 mm (5.9 in) PVC pigtail with QD, or 2 m (6.5 ft) integral cable, depending on model

Operating Conditions:

General-Purpose: -40° to +50° C (-40° to +122° F)

Standard and Sealed Audible: -20° to +50° C (-4° to +122° F)

Max. Rel. Humidity: 95% at 50° C (non-condensing)

Vibration and Mechanical Shock:

All models meet Mil. Std. 202F requirements method 201A (vibration: 10 to 60 Hz max., double amplitude 0.06", maximum acceleration 10G). Also meets IEC 947-5-2; 30G 11 ms duration, half sine wave.

Construction:

Bases and Covers: ABS

Light Segment: Polycarbonate

Audible Adjustment

Standard Audible Alarm: Unscrew the cover (up to 1.5 turns max.) to adjust the audible intensity. (Do not exceed 1.5 turns or the cover may detach during operation.) For max. intensity, rotate the center plug 180° counterclockwise to remove it.

Sealed Audible Alarm: Rotate the front cover until the desired intensity is reached.

Audible Alarm

Audible measurements are made in the direction sound exits the device. For standard audible models, this is the top of the unit (when mounted vertically, sound is directed toward the ceiling). For sealed audible models, sound exits the vented openings in the side of the unit, which should be oriented so that the sound is directed toward the machine operator(s). In environments with high ambient noise levels or high ceilings that absorb sound, the sealed version is recommended.

Standard Audible Alarm: 2.7 KHz ± 500 Hz oscillation frequency; max. intensity 92 db at 1 m (3.3 ft) (typical)

Sealed Audible Alarm: 2.9 KHz ± 250 Hz oscillation frequency; max. intensity 94 db at 1 m (3.3 ft) (typical)

Environmental Rating

General-Purpose and Sealed Audible: IEC IP67

Standard Audible: IEC IP50

Certifications



Dimensions

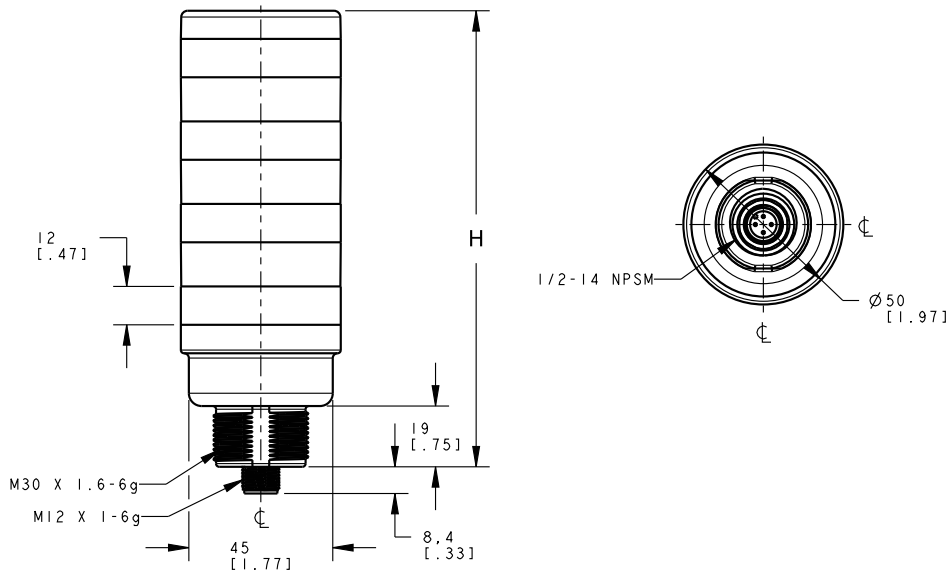

# of Colors	Tower Height (H)		
	General-Purpose Models	Standard Audible Models†	Sealed Audible Models
1	46.2 mm (1.8 in)	77.1 mm (3.1 in)	100.2 mm (4.0 in)
2	72.0 mm (2.8 in)	102.9 mm (4.1 in)	126.0 mm (5.0 in)
3	97.8 mm (3.8 in)	128.7 mm (5.1 in)	151.8 mm (6.0 in)
4	123.6 mm (4.8 in)	154.5 mm (6.1 in)	177.6 mm (7.0 in)
5	149.4 mm (5.8 in)	-	-

† Tower height (H) with top unscrewed approximately 3.5 mm to allow sound to escape

Hookups – 4-Pin Models

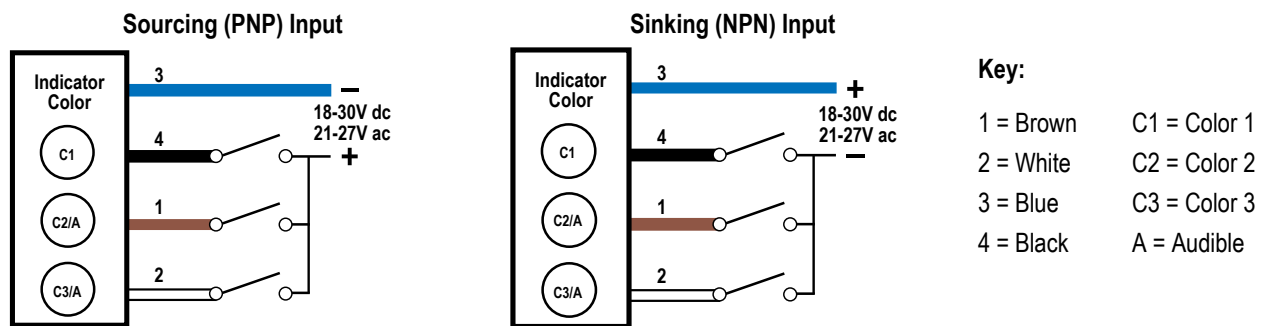

Pins 1 and 2 could activate the corresponding color or the audible function, if available.

Hookups – 5-Pin Models

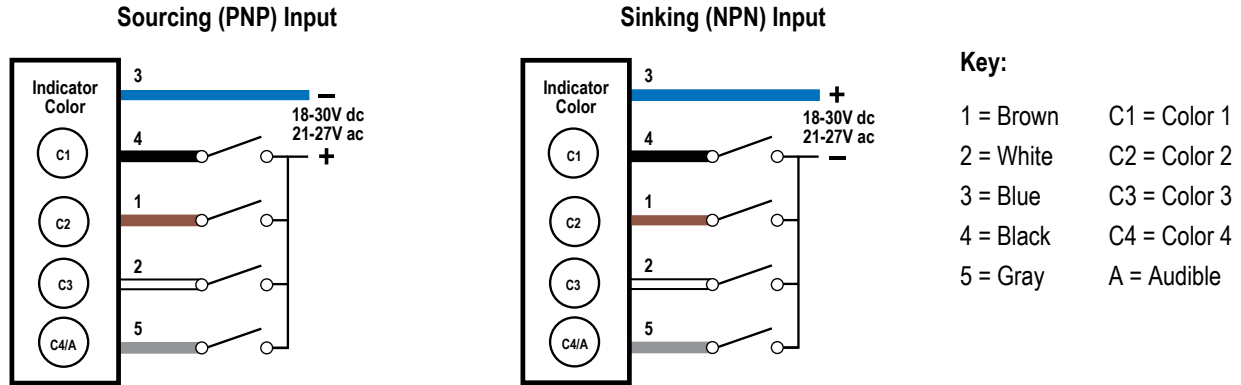

Pin 5 could activate the corresponding color or the audible function, if available.

Hookups – 8-Pin Models

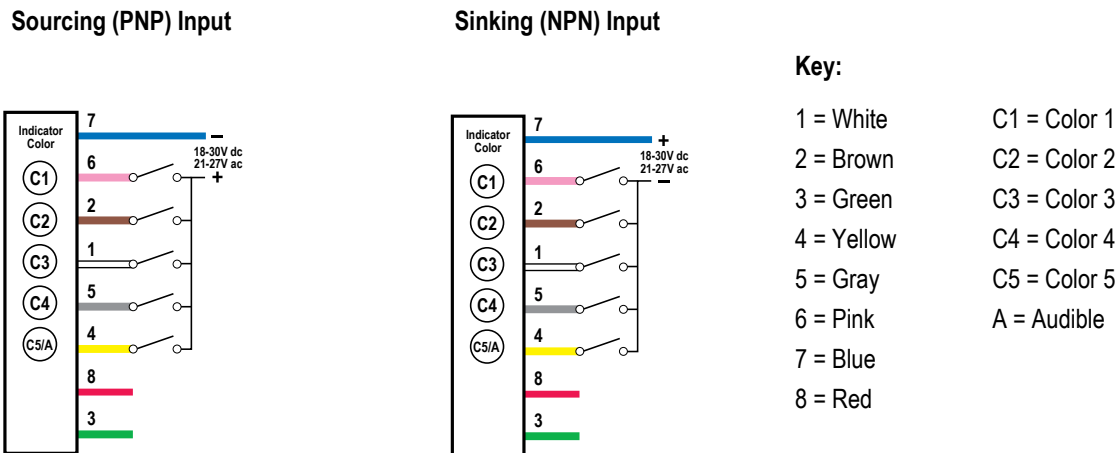

Pin 4 could activate the corresponding color or the audible function, if available. Pins 3 and 8 are not used.

Accessories

Quick-Disconnect (QD) Cordsets

4-Pin Threaded M12/Euro-Style Cordsets				
Model	Length	Style	Dimensions	Pinout
MQDC-406	1.83 m (6 ft)	Straight		
MQDC-415	4.57 m (15 ft)			
MQDC-430	9.14 m (30 ft)			
MQDC-450	15.2 m (50 ft)			

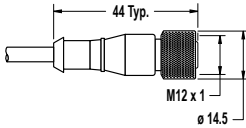
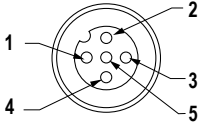
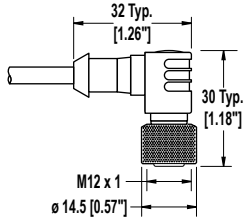
5-Pin Threaded M12/Euro-Style Cordsets				
Model	Length	Style	Dimensions	Pinout
MQDC1-501.5	0.50 m (1.5 ft)	Straight		 <p>1 = Brown 2 = White 3 = Blue 4 = Black 5 = Gray</p>
MQDC1-506	1.83 m (6 ft)			
MQDC1-515	4.57 m (15 ft)			
MQDC1-530	9.14 m (30 ft)			
MQDC1-506RA	1.83 m (6 ft)	Right-Angle		
MQDC1-515RA	4.57 m (15 ft)			
MQDC1-530RA	9.14 m (30 ft)			

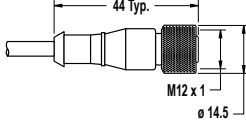
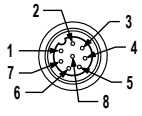
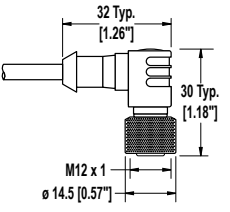
8-Pin Threaded M12/Euro-Style Cordsets with Open-Shield				
Model	Length	Style	Dimensions	Pinout
MQDC2S-806	1.83 m (6 ft)	Straight		 <p>1 = White 2 = Brown 3 = Green 4 = Yellow 5 = Gray 6 = Pink 7 = Blue 8 = Red</p>
MQDC2S-815	4.57 m (15 ft)			
MQDC2S-830	9.14 m (30 ft)			
MQDC2S-850	15.2 m (50 ft)			
MQDC2S-806RA	1.83 m (6 ft)	Right-Angle		
MQDC2S-815RA	4.57 m (15 ft)			
MQDC2S-830RA	9.14 m (30 ft)			
MQDC2S-850RA	15.2 m (50 ft)			

Mounting Brackets

SMB30A

- Right-angle bracket with curved slot for versatile orientation
- Clearance for M6 (¼ in) hardware
- Mounting hole for 30 mm sensor
- 12-ga. stainless steel

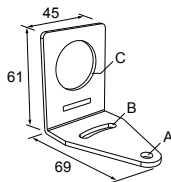

SMB30FA

- Swivel bracket with tilt and pan movement for precise adjustment
- Mounting hole for 30 mm sensor
- 12-ga. 304 stainless steel
- Easy sensor mounting to extrude rail T-slot

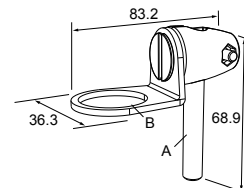

Hole center spacing: A to B=40
Hole size: A=∅ 6.3, B= 27.1 x 6.3, C=∅ 30.5

- Metric and inch size bolt available

Bolt thread: SMB30FA, A= 3/8 - 16 x 2 in; SMB30FAM10, A= M10 - 1.5 x 50
Hole size: B= ∅ 30.1

SMB30MM

- 12-ga. stainless steel bracket with curved mounting slots for versatile orientation
- Clearance for M6 (1/4 in) hardware
- Mounting hole for 30 mm sensor

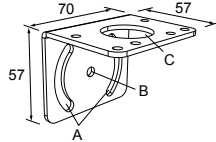

Hole center spacing: A = 51, A to B = 25.4
Hole size: A = 42.6 x 7, B = ∅ 6.4, C = ∅ 30.1

SMB30SC

- Swivel bracket with 30 mm mounting hole for sensor
- Black reinforced thermo-plastic polyester
- Stainless steel mounting and swivel locking hardware included

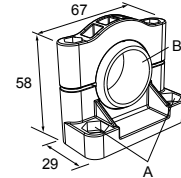

Hole center spacing: A=∅ 50.8
Hole size: A=∅ 7.0, B=∅ 30.0

SMB30SK

- Flat-mount swivel bracket with extended range of motion
- Black reinforced thermo-plastic polyester and 316 stainless steel
- Stainless steel swivel locking hardware included

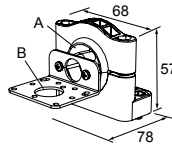

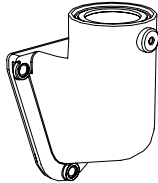
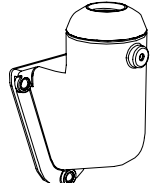

Hole center spacing: A = 50.8
Hole size: A = ∅ 7, B = ∅ 18

LMB Sealed Right-Angle Bracket

Model	Description	Construction	
LMB30RA	Direct-Mount Models: Bracket kit with base, 30 mm adapter, set screw, fasteners, o-rings, and gaskets	Black polycarbonate	
LMB30RAC		Gray polycarbonate	
LMBE12RA	Pipe-Mount Models: Bracket kit with base, 1/2-14 pipe adapter, set screw, fasteners, o-rings, and gaskets. For use with stand-off pipe (listed and sold separately)	Black polycarbonate	
LMBE12RAC		Gray polycarbonate	

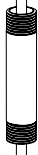
Elevated Mount System

Model			Features	Components
SA-M30TE12 - Black Acetal			<ul style="list-style-type: none"> Streamlined black acetal or white UHMW stand-off pipe adapter/cover Connects between 30 mm light base and ½ in. NPSM/DN15 pipe Mounting hardware included 	
SA-M30TE12C - White UHMW				
Polished 304 Stainless Steel	Black Anodized Aluminum	Clear Anodized Aluminum	<ul style="list-style-type: none"> Elevated-use stand-off pipe (½ in. NPSM/DN15) Polished 304 stainless steel, black anodized aluminum, or clear anodized aluminum surface ½ in. NPT thread at both ends Compatible with most industrial environments 	
SOP-E12-150SS 150 mm (6 in) long	SOP-E12-150A 150 mm (6 in) long	SOP-E12-150AC 150 mm (6 in) long		
SOP-E12-300SS 300 mm (12 in) long	SOP-E12-300A 300 mm (12 in) long	SOP-E12-300AC 300 mm (12 in) long		
SOP-E12-900SS 900 mm (36 in) long	SOP-E12-900A 900 mm (36 in) long	SOP-E12-900AC 900 mm (36 in) long		
SA-E12M30 - Black Acetal			<ul style="list-style-type: none"> Streamlined black acetal or white UHMW mounting base adapter/cover Connects between ½ in. NPSM/DN15 pipe and 30 mm (1-3/16 in) drilled hole Mounting hardware included 	
SA-E12M30C - White UHMW				

Banner Engineering Corp Limited Warranty

Banner Engineering Corp. warrants its products to be free from defects in material and workmanship for one year following the date of shipment. Banner Engineering Corp. will repair or replace, free of charge, any product of its manufacture which, at the time it is returned to the factory, is found to have been defective during the warranty period. This warranty does not cover damage or liability for misuse, abuse, or the improper application or installation of the Banner product.

THIS LIMITED WARRANTY IS EXCLUSIVE AND IN LIEU OF ALL OTHER WARRANTIES WHETHER EXPRESS OR IMPLIED (INCLUDING, WITHOUT LIMITATION, ANY WARRANTY OF MERCHANTABILITY OR FITNESS FOR A PARTICULAR PURPOSE), AND WHETHER ARISING UNDER COURSE OF PERFORMANCE, COURSE OF DEALING OR TRADE USAGE.

This Warranty is exclusive and limited to repair or, at the discretion of Banner Engineering Corp., replacement. **IN NO EVENT SHALL BANNER ENGINEERING CORP. BE LIABLE TO BUYER OR ANY OTHER PERSON OR ENTITY FOR ANY EXTRA COSTS, EXPENSES, LOSSES, LOSS OF PROFITS, OR ANY INCIDENTAL, CONSEQUENTIAL OR SPECIAL DAMAGES RESULTING FROM ANY PRODUCT DEFECT OR FROM THE USE OR INABILITY TO USE THE PRODUCT, WHETHER ARISING IN CONTRACT OR WARRANTY, STATUTE, TORT, STRICT LIABILITY, NEGLIGENCE, OR OTHERWISE.**

Banner Engineering Corp. reserves the right to change, modify or improve the design of the product without assuming any obligations or liabilities relating to any product previously manufactured by Banner Engineering Corp.