

Damotech Product Sheets

DAMO PRO

1/4" Plates + 1/2" Grade 5 Bolts

1 1/2 x 1 1/2 x 1/8" Tubing

1/4" Bent Plate

3 x 3 x 1/4" Tubing

C3 Channel

5/8 x 4" Hilti Kwik Hus Anchors
17,500 lb Shearing capacity each



US Patents 6,405,884; 6,298,537 - Canadian Patents 2,280,645; 2,232,178

DAMO PRO

The Damo Pro is the workhorse of the Damotech line. It is used to permanently repair and reinforce damaged front columns.

Extended footplates (with or without bullnose), seismic footplates and seismic anchors and are also available
Color: Orange (standard) / Other colors and a galvanized finish also available
The Damo Pro can accommodate multiple levels of beams

DAMOTECH

DAMO PRO DBRS

Adjustable Brace

1/4" Plates + 1/2" Grade 5 Bolts

1/4" Bent Plate

3 x 3 x 1/4" Tubing

1 1/2 x 1 1/2 x 1/8" Tubing

C3 Channel

5/8 x 4" Hilti Kwik Hus Anchors
17,500 lb Shearing capacity each



US Patents 6,405,884; 6,298,537 - Canadian Patents 2,280,645; 2,232,178

DAMO PRO DBRS

The Damo Pro DBRS is a repair solution from the Damotech line. It is used to permanently repair and reinforce damaged front and rear columns. The adjustable brace respects the original configuration and integrity of the rack.

Extended footplates (with or without bullnose), seismic footplates and seismic anchors and are also available
Color: Orange (standard) / Other colors and a galvanized finish also available
The Damo Pro DBRS can accommodate multiple levels of beams

DAMOTECH

DAMO CAN

1/4" Bent Plate

Adjustable Brace

CANT at:
36, 48, 60 or 72"

1/4" Plates + 1/2" Grade 5 Bolts

1 1/2 x 1 1/2 x 1/8" Tubing

3 x 3 x 1/4" Tubing

C3 Channel

5/8 x 4" Hilti Kwik Hus Anchors
17,500 lb Shearing capacity each

US Patents 6,405,884; 6,298,537 - Canadian Patents 2,280,645; 2,232,178

DAMO CAN

The Damo Can is a permanent repair solution from the Damotech line. It is used to permanently repair and reinforce double deep racking and drive-in systems. This is also a good option where forklift maneuvering is difficult.

Extended footplates, seismic footplates and seismic anchors are also available
Color: Orange (standard) / Other colors and a galvanized finish also available
The Damo Can can accommodate multiple levels of beams

DAMOTECH

DAMO FLEX



US Patents 6,405,884; 6,298,537 - Canadian Patents 2,280,645; 2,232,178

DAMO FLEX

The Damo Flex is used to repair damaged front or back columns on a racking system and bring back the original loading capacity of the rack. The first horizontal and diagonal braces are included. Other braces sold separately.

Extended footplates (with or without bullnose), seismic footplates and seismic anchors and are also available
Color: Metallic gray (standard) / Galvanized finish also available
The Damo Flex can accommodate multiple levels of beams

DAMOTECH

DAMO FLEX DBRS



US Patents 6,405,884; 6,298,537 - Canadian Patents 2,280,645; 2,232,178

DAMO FLEX DBRS

The Damo Flex DBRS is used to repair damaged front and back columns on a racking system and bring back the original loading capacity of the rack. The first horizontal and diagonal braces are included. Other braces sold separately.

Extended footplates (with or without bullnose), seismic footplates and seismic anchors and are also available
Color: Metallic gray (standard) / Galvanized finish also available
The Damo Flex can accommodate multiple levels of beams

DAMOTECH

DAMO GUARD

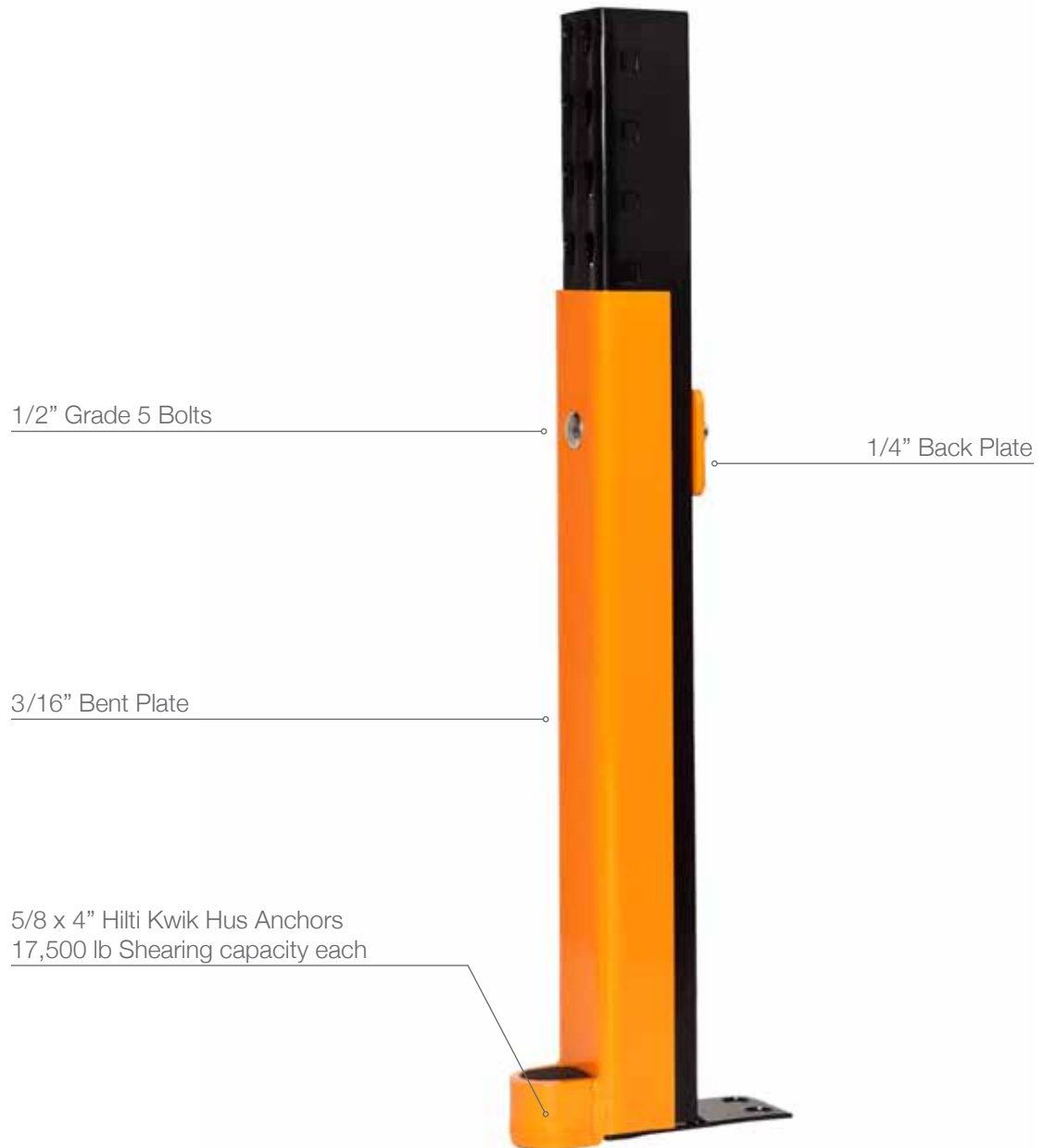

DAMO GUARD

The Damo Guard is a preventive solution from the Damotech line. It is used to help prevent damage and possible side twisting on front columns.

24, 36 and 48" heights available / Adaptable to seismic footplate (if necessary)
Color: Orange (standard) / Other colors and a galvanized finish also available

DAMOTECH

DAMO SUPER GUARD



DAMO SUPER GUARD

The Damo Super Guard is a heavy duty protective solution from the Damotech line. It is used in high risk areas to help prevent damage and possible side twisting on front columns. It has an extremely high resistance to impact and can fit over a Frazier bullnose rack system.

Color: Orange (standard) / Other colors and a galvanized finish also available

DAMOTECH

DAMO KING



US Patents 6,405,884; D451,311 S - Canadian Industrial Design 95,913

DAMO KING

The Damo King is used as a preventive solution on new racking systems to further protect uprights from impact and abuse.

Seismic footplates, seismic anchors and extended footplates are also available
Color: Orange (standard) / Other colors and a galvanized finish also available

DAMOTECH

DAMO SHIELD

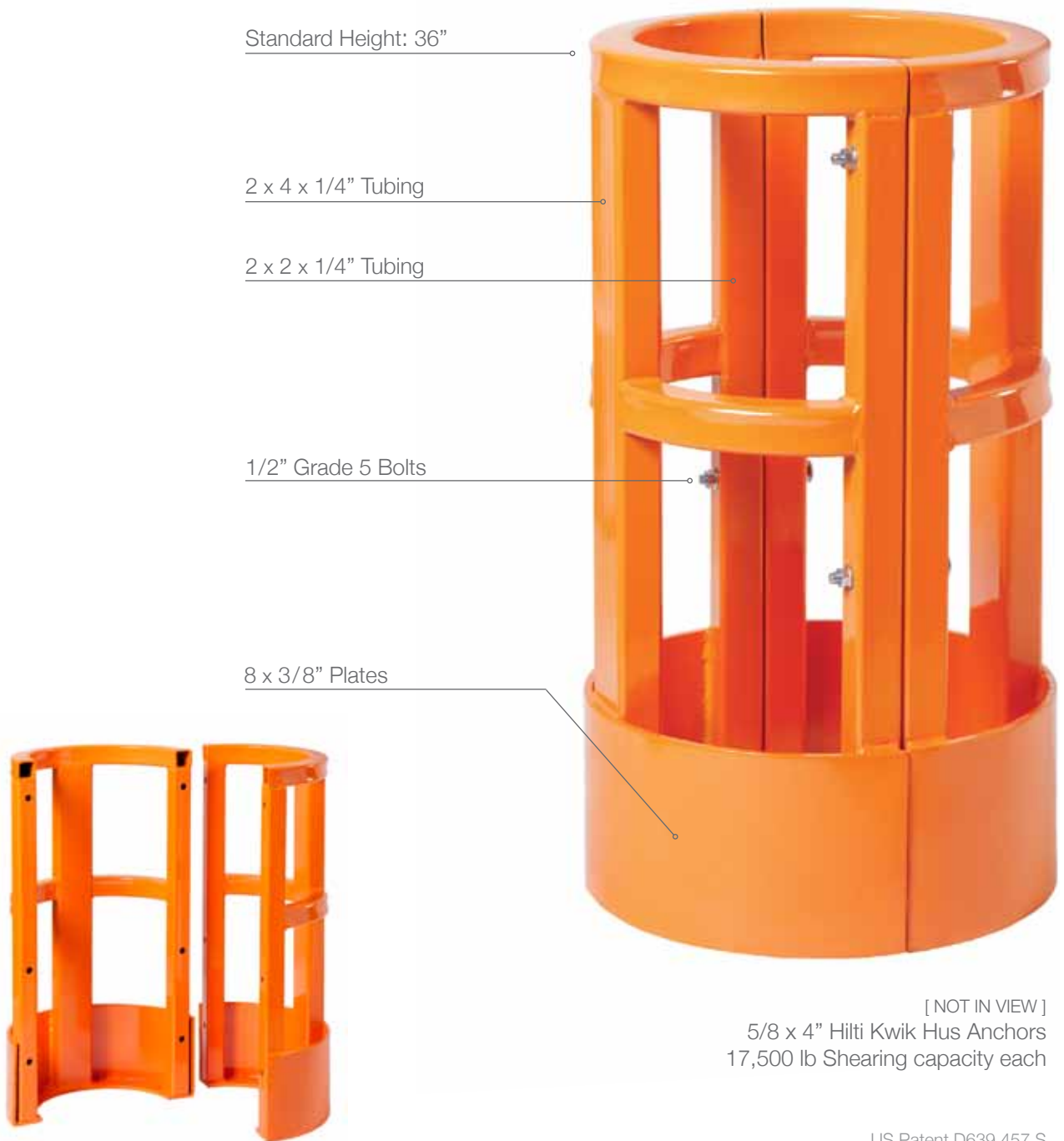

DAMO SHIELD

The Damo Shield is a heavy duty protective solution from the Damotech line. It is used to protect building columns of up to 10 inches in diameter. It also protects any mechanicals running next to the columns. Custom shapes (oval) and sizes are available.

Color: Orange (standard) / Other colors and a galvanized finish also available

DAMOTECH

DAMO FENCE



[NOT IN VIEW]

5/8 x 4" Hilti Kwik Hus Anchors
17,500 lb Shearing capacity each

3/8" Stiffeners

DAMO FENCE

The Damo Fence is a heavy duty protective solution from the Damotech line. It is used in high risk areas and can be customized to your needs in terms of shape, height and length. It has an extremely high resistance to impact.

Color: Orange (standard) / Other colors and a galvanized finish also available

DAMOTECH

DAMO GUIDE

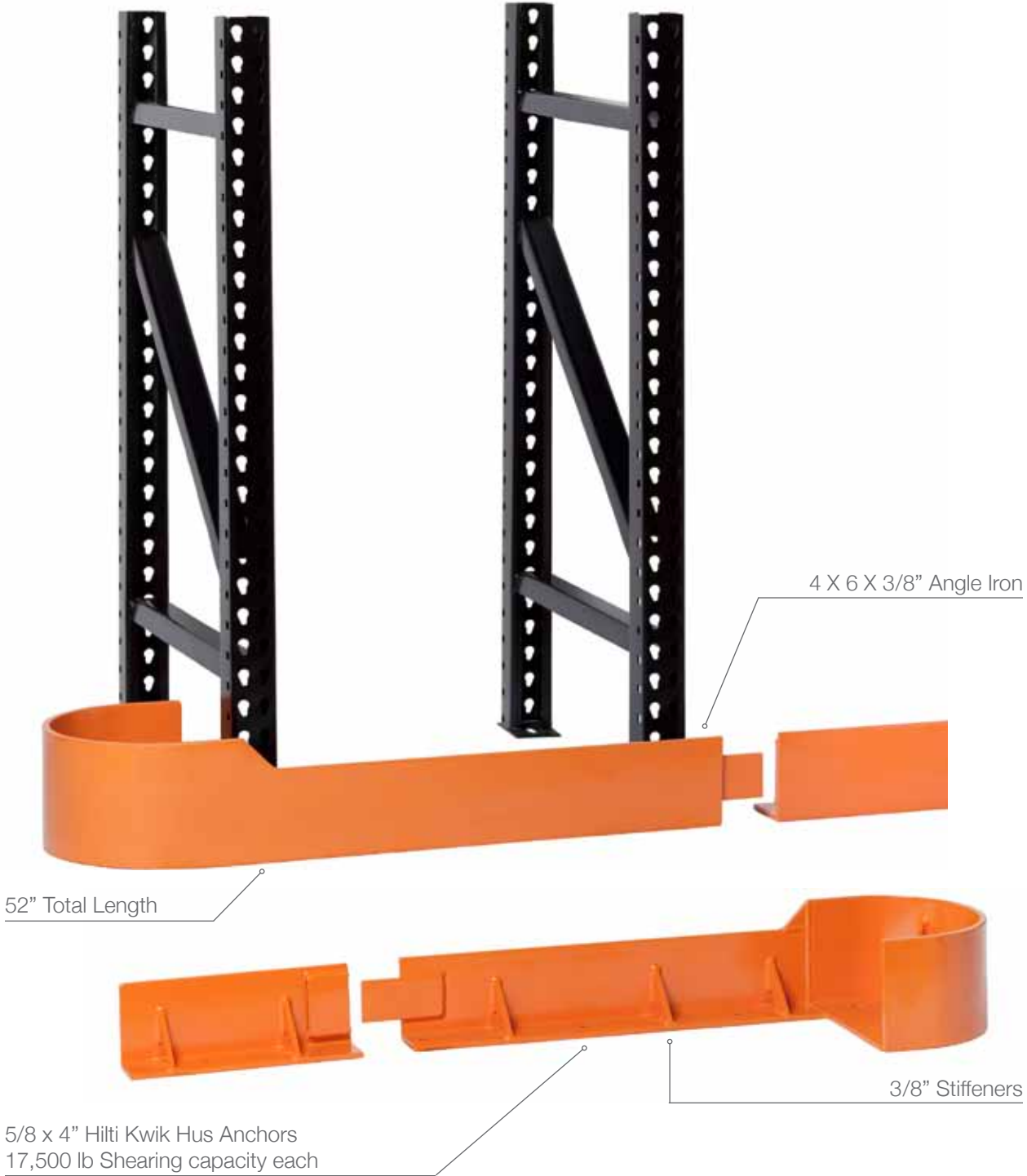

DAMO GUIDE

The Damo Guide is a protective solution from the Damotech line. It is used for narrow aisle entry configurations, as it helps lift trucks follow a defined path, away from uprights. It is adaptive in length to accommodate your needs.

Color: Orange (standard) / Other colors and a galvanized finish also available

DAMOTECH

DAMO END GUARD



3/8" Thick Angle Iron



5/8 x 4" Hilti Kwik Hus Anchors
17,500 lb Shearing capacity each

3/8" Stiffeners

DAMO END GUARD

The Damo End Guard is a protective solution from the Damotech line. It is used to protect the end of aisles against damage from lift traffic. It is adaptive in length to fit your needs.

Color: Orange (standard) / Other colors and a galvanized finish also available

DAMOTECH

DAMO ADJUSTABLE BRACE

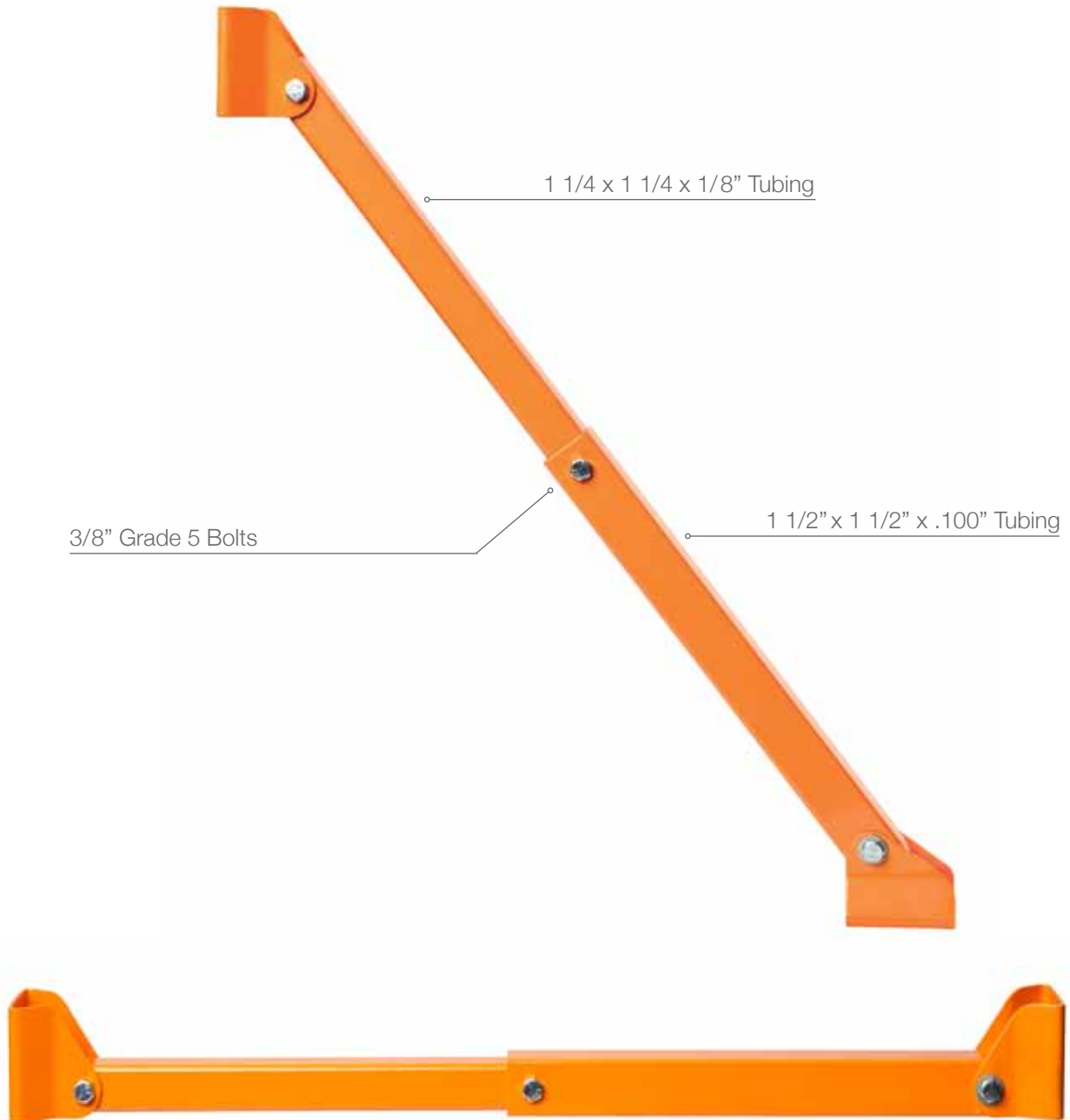

ADJUSTABLE BRACE

The adjustable brace is a universal design used to replace damaged horizontal and diagonal braces and maintain an original upright configuration. A heavy duty option is also available.

Color: Orange (standard) / Other colors and a galvanized finish also available

DAMOTECH

DAMO SPLICE

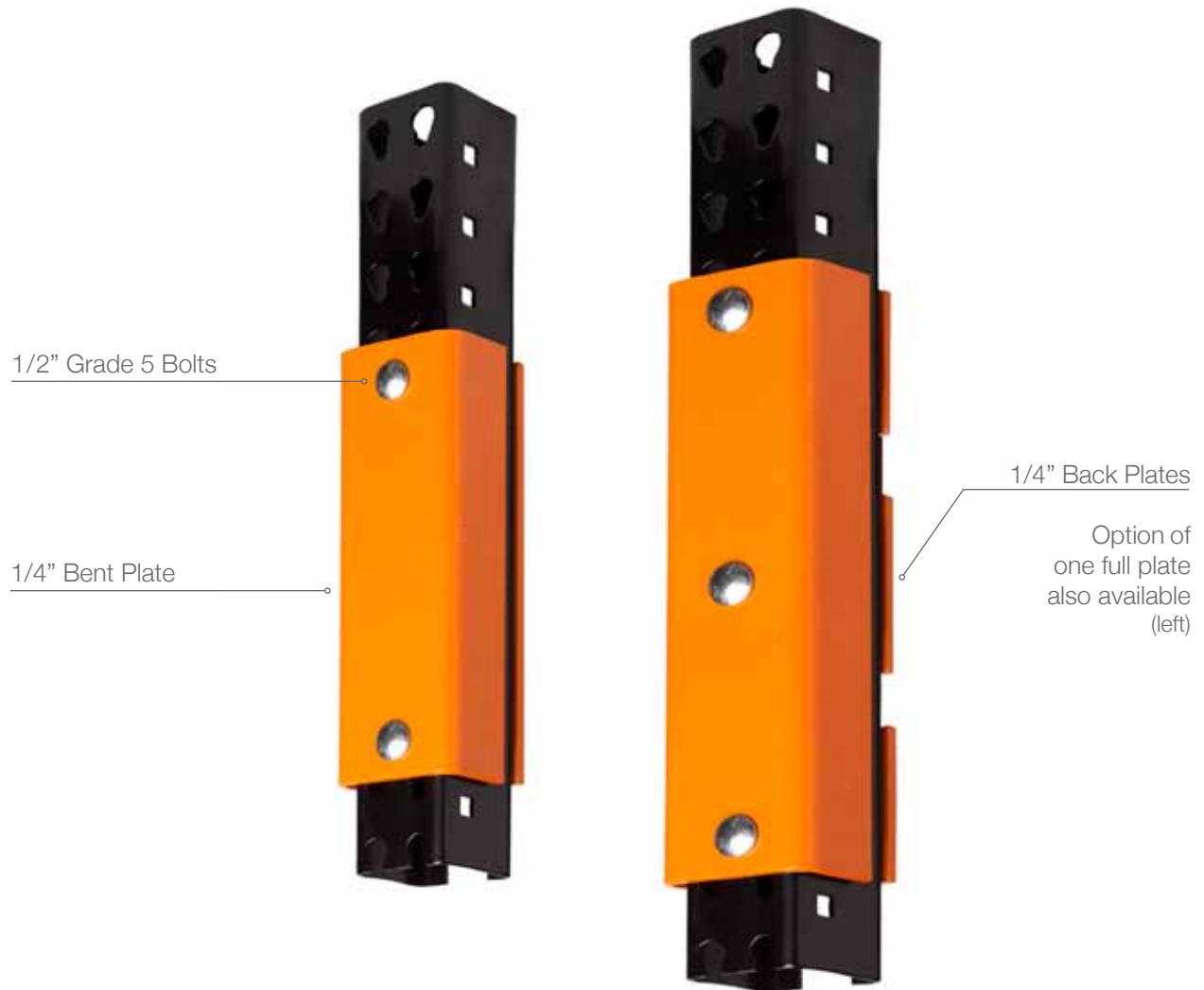

DAMO SPLICE

The Damo Splice kit is designed to reinforce light column damage above 48" in height or above the first beam level (whichever comes first). A heavy duty option is also available.

Color: Orange (standard) / Other colors and a galvanized finish also available

DAMOTECH

DAMO PALLET STOPPER



DAMO PALLET STOPPER

The Damo Pallet Stopper is a protective solution from the Damotech line. It is used to protect walls or back frames against pallet impact at floor level. The standard length is 24" but it can be adapted to fit your needs.

Color: Orange (standard) / Other colors and a galvanized finish also available

DAMOTECH

DAMO RAIL STOPPER

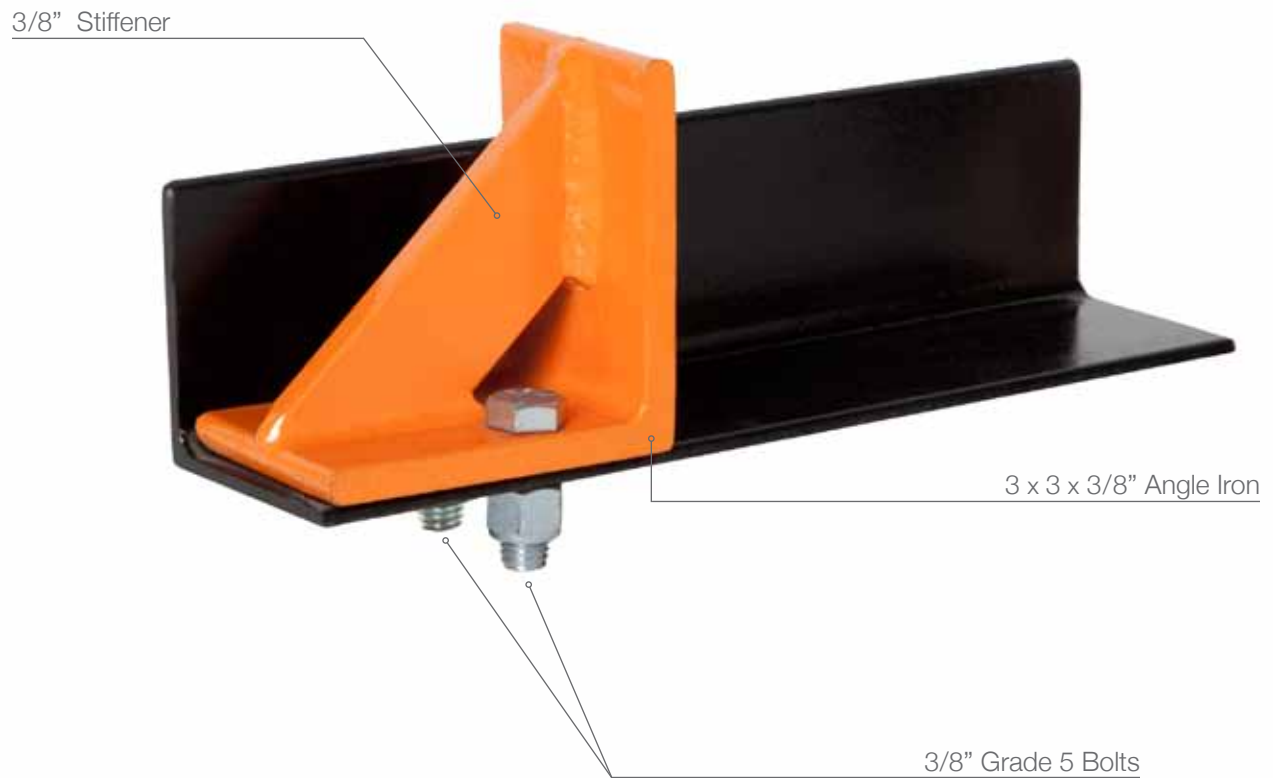

DAMO RAIL STOPPER

The Damo Rail Stopper is a protective solution from the Damotech line. It is used to protect walls and back frames against pallet impacts at rail level.

Color: Orange (standard) / Other colors and a galvanized finish also available

DAMOTECH

DAMO ROW SPACER

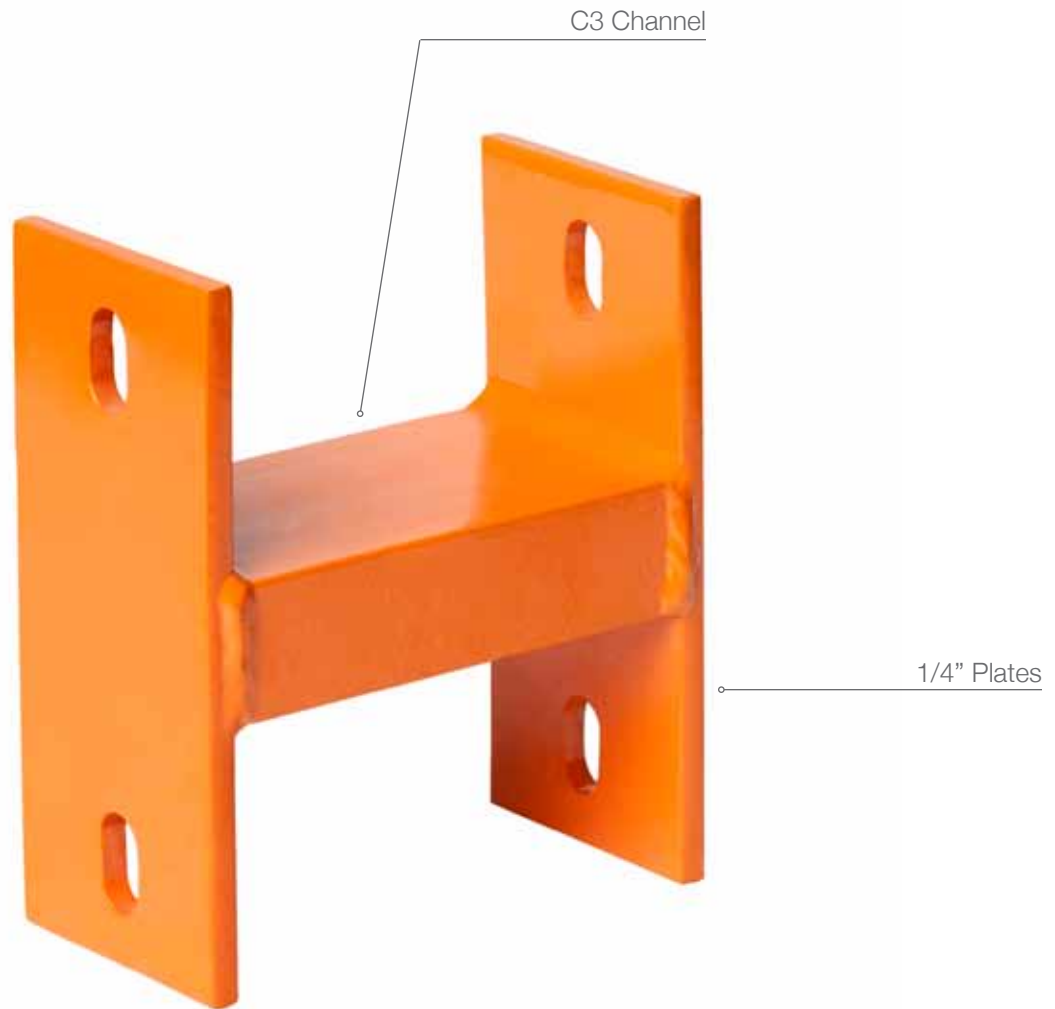

DAMO ROW SPACER

The Damo Row Spacer is designed to connect two columns or support a Damo Deflex at the end of an aisle or for drive-in applications. Standard and Heavy Duty option available. It is adaptive in size to accommodate your needs.

Color: Orange (standard) / Other colors and a galvanized finish also available

DAMOTECH

DAMO DEFLEX



5/16" Plate
12" Standard Height

DAMO DEFLEX

The Damo Deflex is a preventive solution from the Damotech line. It is used to protect uprights from side impacts and abuse from drive in tunnels and end of aisle applications. It must be installed with other Damotech products.

Color: Orange (standard) / Other colors and a galvanized finish also available

DAMOTECH

DAMOTECH PATENTS

Damotech owns the following patents governing its products:

Damo Pro, Damo Pro DBRS, Damo Flex, Damo Flex DBRS

US Patents 6,405,884; 6,298,537

Canadian Patents 2,280,645; 2,232,178

Patents also granted in the UK, Germany, France, and Spain.

Damo Easy Lift and Damo Lite Lift

US Patents 6,405,884; 6,298,537

Canadian Patents 2,280,645; 2,232,178

Damo Can

US Patents D490,678 S; D488,056 S

Canadian Industrial Designs 99,075; 99,076

Damo King

US Patents 6,405,884; D451,311 S

Canadian Industrial Design 95,913

Damo Shield

US Patent D639,457 S